

For DC screwdrivers

# Power Supply

## Exclusive power supply is required for DC screwdrivers.

- Exclusive power supply converts the electric current from AC outlet (on the primary side) to low-voltage output (HI: DC30V) or (LOW: about DC20V) to supply it to the screwdriver.
- Safe and quiet rotation.
- Please always use HIOS screwdriver in combination with HIOS power supply for safe screw tightening.
- Stable power supply with multiple inputs (AC100V to 240V).  
(Not applicable to CLT-100 and MC-70L)

## Power supply for brushless screwdrivers



### ● Combination of power supply and screwdriver

Number of connectable screwdrivers		1 unit	
Power supply		T-30BL	T-70BL
Screwdriver (Including OPC type)			
BLG Series	BLG-4000	●	●
	BLG-5000	—	●
BL Series	BL-2000	●	●
	BL-3000	●	●
	BL-5000	—	●
	BL-7000	—	●

Model: T-30BL (for one screwdriver)		RoHS	CE	UL	CCC
<b>Compatible screwdrivers</b>					
BLG Series BL Series (Including OPC type)					
					
Primary input power source	AC100-240V (47-63Hz)				
Secondary output voltage	HI(2): DC30V, LOW(1): DC20V (2-step switchable)				
External dimensions (mm)	62(W) × 134(D) × 40 (H) mm				
Weight (g)	300 g				
Accessories	Power supply cord 1.8m (1pc), Flat 2P conversion plug (1pc) (only for 100V), Mounting hardware (2pcs), Mounting screws (4pcs)				
Plug type	A	A-2	A-3/C/BF/S		
Compatible screwdrivers	BLG Series	BLG-4000			
	BL Series	BL-2000, BL-3000			

Model: T-70BL (for one screwdriver)		RoHS	CE	UL	CCC
<b>Compatible screwdrivers</b>					
BLG Series BL Series (Including OPC type)					
					
Primary input power source	AC100-240V (47-63Hz)				
Secondary output voltage	HI(2): DC30V, LOW(1): DC20V (2-step switchable)				
External dimensions (mm)	88(W) × 210(D) × 52 (H) mm				
Weight (g)	685 g				
Accessories	Power supply cord 1.8m (1pc), Flat 2P conversion plug (1pc) (only for 100V), Mounting hardware (2pcs), Mounting screws (4pcs)				
Plug type	A	A-2	A-3/C/BF/S		
Compatible screwdrivers	BLG Series	BLG-4000, BLG-5000			
	BL Series	BL-2000, BL-3000, BL-5000, BL-7000			

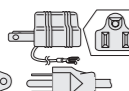
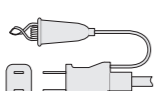
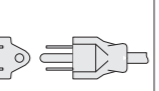
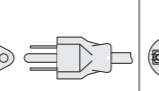
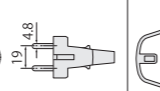
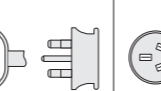
### ● Plug type

Voltage	100V		120V		220-240V		
	Type A	Type A-1	Type A-2	Type A-3	Type C	Type BF	Type S
Plug type							

## Power Supply for Brushed Screwdrivers

### ● Combination of power supply with screwdriver

Number of connectable screwdrivers		1 unit		2 units		More than 2 MC-70L + CB-105 (SUB) Control box	
Power supply		CLT-30	CLT-60	CLT-80	CLT-100	MC-70L	
Screwdriver							
CL Series	CL-2000	●	●	—	●	●	(Max. 20 units)
	CL-3000	●	●	—	●		
	CL-4000	—	●	—	●		
	CL-6000	—	●	—	●		
	CL-6500	—	●	—	●		
	CL-7000	—	●	—	●		
SS Series	SS-2000	●	●	—	●	●	(Max. 20 units)
	SS-3000	●	●	—	●		
	SS-4000	—	●	—	●		
	SS-6500	—	●	—	●		
	SS-7000	—	●	—	●		
α Series	α-4500	—	●	—	●	●	(Max. 10 units)
	α-5000	—	●	—	●		
	α-6500	—	●	—	●		

Model: CLT-30 (for one screwdriver)		RoHS	CE	UL	CCC
<b>Compatible screwdrivers</b>					
CL Series SS Series					
					
Primary input power source	AC100-240V (47-63 Hz)				
Secondary output voltage	HI(2): DC30V, LOW(1): DC20V (2-step switchable)				
External dimensions (mm)	62(W) × 134(D) × 40 (H) mm				
Weight (g)	300 g				
Accessories	Power supply cord 1.8m (1pc), Flat 2P conversion plug (1pc) (only for 100V), Mounting hardware (2pcs), Mounting screws (4pcs)				
Plug type	A	A-2	A-3/C/BF/S		
Compatible screwdriver	CL Series	CL-2000, CL-3000			
	SS Series	SS-2000, SS-3000			

Model: CLT-60 (for one screwdriver)		RoHS	CE	UL	CCC
<b>Compatible screwdrivers</b>					
CL Series SS Series α Series					
					
Primary input power source	AC100-240V (47-63 Hz)				
Secondary output voltage	HI(2): DC30V, LOW(1): DC20V (2-step switchable)				
External dimensions (mm)	88(W) × 210(D) × 52 (H) mm				
Weight (g)	715 g				
Accessories	Power supply cord 1.8m (1pc), Flat 2P conversion plug (1pc) (only for 100V), Mounting hardware (2pcs), Mounting screws (4pcs)				
Plug type	A	A-2	A-3/C/BF/S		
Compatible screwdriver	CL Series	CL-2000, CL-3000, CL-4000, CL-6000, CL-6500, CL-7000			
	SS Series	SS-2000, SS-3000, SS-4000, SS-6500, SS-7000			
	α Series	α-4500, α-5000, α-6500			

Model: CLT-80 (for one screwdriver)		RoHS	CE
<b>Compatible screwdrivers</b>			
CL-9000 only			
			
Primary input power source	AC100V-240V (47/63Hz)		
Secondary output voltage	HI(2) : DC30V, LOW(1):DC20V (2-step switches)		
External dimensions (mm)	114(W) × 215(D) × 52(H)mm		
Weight (g)	1.6kg		
Accessories	Power supply cord 1.8m (1pc), Flat 2P conversion plug (1pc) (only for 100V), Mounting hardware (2pcs), Mounting screws (4pcs)		
Plug type	A	A-2	A-3/C/BF/S
Compatible screwdriver	CL Series	CL-9000	

Model: CLT-100 (for two screwdrivers)		RoHS	
<b>Compatible screwdrivers</b>			
CL Series SS Series α Series			
			
Primary input power source	AC100V (50/60Hz)	AC120V (50/60Hz)	AC220-240V (50/60Hz)
Secondary output voltage	HI(2): approx. DC30V, LOW(1): approx. DC20V (2-step switchable)		
External dimensions (mm)	182(W) × 145(D) × 132(H)mm		
Weight (g)	4kg		
Accessories	Power supply cord 1.8m with ground wire (1pc)		
Plug type	A-1	A-2	A-3/C/BF/S
Compatible screwdriver	CL Series	CL-2000, CL-3000, CL-4000, CL-6000, CL-6500	
	SS Series	SS-2000, SS-3000, SS-4000, SS-6500	
	α Series	α-4500, α-5000	

Model: **MC-70L** (for multiple screwdrivers)

RoHS

**Compatible screwdrivers**  
CL Series  
SS Series  
α Series



Primary input power source	AC100V (50/60Hz)	AC120V (50/60Hz)	AC220-240V (50/60Hz)
Secondary output voltage	HI(2): about DC30V, LOW(1): about DC20V (2-step switchable)		
External dimensions (mm)	320(W) × 220(D) × 153(H)mm		
Weight (kg)	12kg		
Accessories	Power supply cord 1.8m with ground wire (1pc), Trunk-line wire 20m (1 set, black & red), Branch wire 0.5m (10 sets, black & red), U-element (Scotch lock) #560B (20 pcs)		
Plug type	A-1	A-2	A-3/C/BF/S
Supported models	Up to 20 units	CL-2000, CL-3000, CL-4000, SS-2000, SS-3000, SS-4000	
	Up to 10 units	CL-6000, CL-6500, CL-7000, SS-6500, SS-7000	
	Up to 5 units	α-4500	

**How to connect CB-105 (SUB)**

There should be an appropriate clearance between the trunk-line wires laid along the assembly line and branch wires.

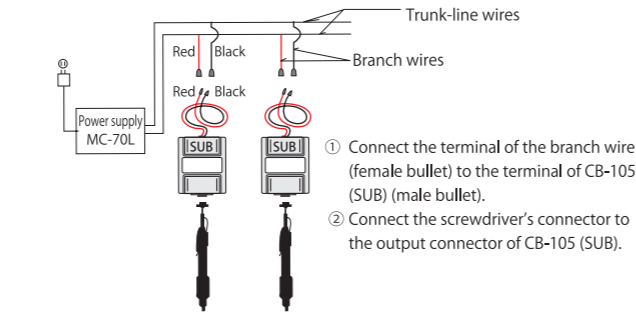

(Note)  
The trunk-line wire (included) of MC-70L should be used with the length within 20m. If you make it longer than 20m, there may be voltage reduction and cause failure of the screwdriver.

**How to use U-element (Scotch lock)**

It is recommended to use U-element (included in this product) to attach a branch wire to the trunk-line wire.

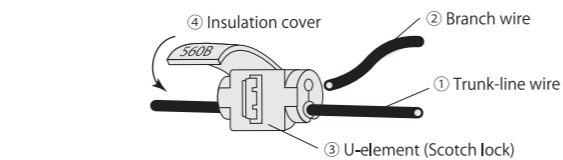

- While push-opening the slot at the bottom of the U-element, push in the trunk-line wire into the groove.
- Insert the end of the branch wire through the upper hole from the right side and push it in all the way to the opposite end.
- Insert the end of the branch wire through the upper hole from the right side and push it in all the way to the opposite end.
- Snap on the insulation cover.

**Control Box CB-105(SUB)**

When you use MC-70L, you need to connect a control box (CB-105, optional) between a screwdriver and MC-70L. CB-105 is a compact control box to control the current in response to the clutch motion of a driver.



Primary input power source	DC20V/31V
Secondary output voltage	Same as the primary input power source
External dimensions (mm)	70(W) × 42(D) × 100 (H) mm
Weight (g)	240 g
Input cord length	2m with a bullet terminal (1pc, fixed to the body)
Accessories	Mounting hardware (2pcs)

《Accessories》 **LEAD KIT for MC-70L Part No. MCCB-SET**  
 ● U-element 20pieces ● Branch wire 10pieces (Black&Red)  
 ● Trunk-line wire 20m 1pieces (Black&Red)

**Power supplies with control function**

Use these power supplies for tightening with low rotation and low torque to avoid impacts and vibrations.

Low rotation and low torque power supply  
Model: **LVT-30** (for one screwdriver)

RoHS

**Compatible screwdrivers**  
CL Series



Start → Complete

Rotation control function	Torque increase function
Fine adjustment for 16 steps with 1V each (0 (minimum) to F (maximum))	Retightening can be set in 4 steps, optimal for tapping screws

**Guide of rotation speed**

Screwdriver models	0 (Min)	1 to E (middle)	F (Max)	* Rotation may slightly vary depending on input voltage
CL-2000	About 120rpm	→	About 480rpm	
CL-3000	About 150rpm	→	About 670rpm	

Primary input power source	AC100-240V (47-63 Hz)
Secondary output voltage	About DC5-20V (16 steps, 1 volt each)
External dimensions (mm)	85(W) × 155(D) × 42 (H) mm
Weight (g)	370g
Accessories	Power supply cord 1.8m (1pc), Flat 2P conversion plug (only for 100V), Mounting hardware (2 pcs), Mounting screws (4 pcs)
Plug type	A A-2 A-3/C/BF/S
Compatible screwdriver CL Series	CL-2000, CL-3000

Low to high voltage adjustable power supply  
Model: **LHT-30** (for one screwdriver)

RoHS

**Compatible screwdrivers**  
CL Series



Start → Complete

Low to High output function	Rotation control function
Low rotation speed just after starting can be set (0, 0.2, 0.4 or 0.6 seconds)	Fine adjustment for 16 steps with 1V each (0 (minimum) to F (maximum))

**Guide of rotation speed**

Screwdriver models	0 (Min)	1 to E (middle)	F (Max)	* Rotation may slightly vary depending on input voltage
CL-2000	About 350rpm	→	About 730rpm	
CL-3000	About 450rpm	→	About 1,000rpm	

Primary input power source	AC100-240V (47-63 Hz)
Secondary output voltage	About DC15-30V (16 steps, 1 volt each)
External dimensions (mm)	85(W) × 155(D) × 42 (H) mm
Weight (g)	370 g
Accessories	Power supply cord 1.8m (1pc), Flat 2P conversion plug (only for 100V), Mounting hardware (2 pcs), Mounting screws (4 pcs)
Plug type	A A-2 A-3/C/BF/S
Compatible screwdriver CL Series	CL-2000, CL-3000

**Special Power Supply • Relay Box**

**Combination of power supply and screwdriver**

Classification	Brushed screwdriver		Brushless screwdriver		
	Low rotation, low torque output power supply	Low to High output voltage adjustable power supply	Power supply with complete signal terminal	CLT-50AF	CLT-75AF
Number of connectable screwdrivers	1 unit	1 unit	1 unit	1 unit	1 unit
Specifications	LVT-30	LHT-30	CLT-50AF	CLT-75AF	BLOP-AF
Screwdrivers	CL-2000	●	●	●	—
	CL-3000	●	●	●	—
	CL-4000	—	—	●	—
	CL-6000	—	—	●	—
	CL-6500	—	—	●	—
	CL-7000	—	—	—	●
	CL-9000	—	—	—	●
	SS-2000	—	—	●	—
	SS-3000	—	—	●	—
	SS-4000	—	—	●	—
	SS-6500	—	—	●	—
	SS-7000	—	—	—	●
	α Series	α-4500	—	●	—
	α-5000	—	●	—	
	α-6500	—	—	●	
BLG Series	BLG-OPC specification	—	—	●	
BL Series	BL-OPC specification	—	—	●	

**Power Supply with Complete Signal + Relay Box**

Use these products to prevent screw tightening skipping or manufacturing line control including a screw counter.

Model: **CLT-50AF** (for one screwdriver)

RoHS

Output signal ● AF (torque increase)

**Compatible screwdrivers**  
CL Series  
SS Series  
α Series



Primary input power source	AC100V (50/60Hz)	
Secondary output voltage	HI (2): about DC30V, LOW (1): about DC20V, 2-step switchable	
External dimensions (mm)	105(W) × 185(D) × 91(H)mm	
Weight (kg)	About 2.7kg	
Accessories	Power supply cord: 1.8m with ground wire (1pc)	
Plug type	A-1	
Compatible screwdrivers	CL Series	CL-2000, CL-3000, CL-4000
	SS Series	SS-2000, SS-3000, SS-4000
	α Series	α-4500, α-5000

Model: **CLT-75AF** (for one screwdriver)

RoHS

Output signal ● AF (torque increase)

**Compatible screwdrivers**  
Exclusive for CL-9000



Primary input power source	AC100V(50/60Hz)
Secondary output voltage	HI (2): about DC30V
External dimensions (mm)	182(W) × 220(D) × 133(H)mm
Weight (kg)	6kg
Accessories	Power supply cord: 1.8m with ground wire (1pc)
Plug type	A-1
Compatible screwdrivers CL Series	CL-9000

Model: **BLOP-AF** (relay box of complete signal)

RoHS

Output signals ● FOR (forward) ● REV (reverse) ● T-UP (torque increase)

**Compatible screwdrivers**  
BLG Series (OPC type)  
BL Series (OPC type)



The signals (FOR, REV and T-UP) from the screwdrivers of OPC-type screwdriver with signal output function, can be extracted with this unit to connect to an external unit such as a sequencer.

Primary input power source	DC30V	
Secondary output voltage	Same as the primary input	
External dimensions (mm)	70(W) × 42(D) × 100(H)mm	
Weight (g)	160g	
Accessories	Screwdriver cable 1.5m (1pc) Mounting hardware (2pcs)	
Compatible screwdrivers	BLG Series	BLG-4000-OPC, BLG-5000-OPC
	BL Series	BL-2000-OPC, BL-3000-O BL-5000-OPC, BL-7000-OPC

**Plug type**

Voltage	100V		120V	220-240V			
	Type A	Type A-1	Type A-2	Type A-3	Type C	Type BF	Type S
Plug type							